

ON-OFF

SCHEMATIC (NON-SHORTING)

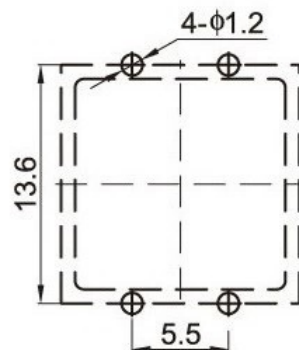
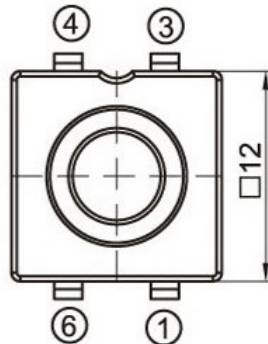

印制线路板

注：“\*”□表示关键尺寸(3个).

NO.	PARTS	MATERIALS	Q'TY		TOLERANCE UNLESS SPECIFIED				
8									
7									
6					WITHIN 1.5mm : $\pm 0.1\text{mm}$	A	2012-8-13	初版	
5	SPRING	SUS	1	NATURAL	OVER 1.5mm : $\pm 0.2\text{mm}$	ISSUE	DATE	DESCRIPTIONS OF REVISION	APPD.
4	CAM STICK	SUS	1	NATURAL	TITLE : VERTICAL PUSH SWITCH		UNIT : mm	DRWG NO.:	
3	CASE	PA66/BRASS STRIP	1	GREY/Ag PLATED	MODEL:		SCALE: 5:1	DWN.	2012-8-13
2	COVER	PA66	1	BLACK	东莞市高迪电子有限公司			CHK'D	
1	KNOB	PA66/PBS C5210R-EH	1	WHITE/Ag CLAD				APPD.	
NO.	PARTS	MATERIALS	Q'TY						

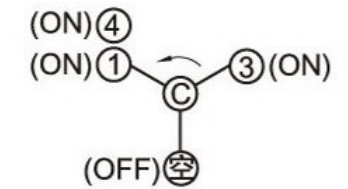
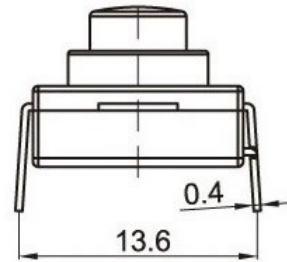
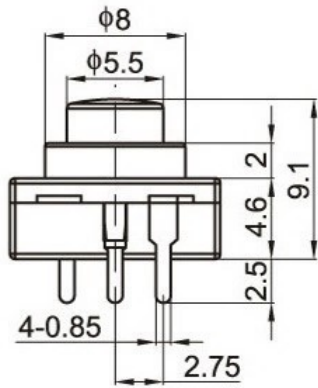
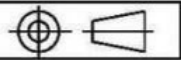

ON-ON-OFF  
SCHEMATIC (NON-SHORTING)

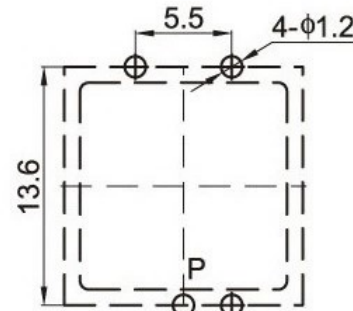
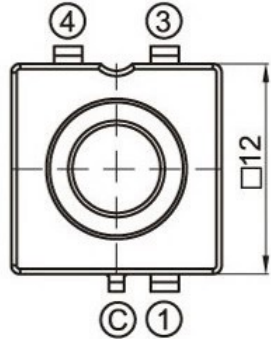

印制线路板  
P.C.B

注：“\*”□表示关键尺寸(3个).

NO.	PARTS	MATERIALS	Q'TY		TOLERANCE UNLESS SPECIFIED				
8									
7									
6					WITHIN 1.5mm : ±0.1mm	A	2012-8-13	初版	
5	SPRING	SUS	1	NATURAL	OVER 1.5mm : ±0.2mm	ISSUE	DATE	DESCRIPTIONS OF REVISION	APPD.
4	CAM STICK	SUS	1	NATURAL	TITLE : VERTICAL PUSH SWITCH		UNIT : mm	DRWG NO.:	
3	CASE	PA66/BRASS STRIP	1	GREY/Ag PLATED	MODEL:		SCALE: 5:1	DWN.	2012-8-13
2	COVER	PA66	1	BLACK	东莞市高迪电子有限公司			CHK'D	
1	KNOB	PA66/PBS C5210R-EH	1	WHITE/Ag CLAD				APPD.	
NO.	PARTS	MATERIALS	Q'TY						

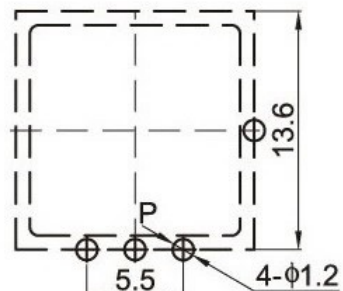
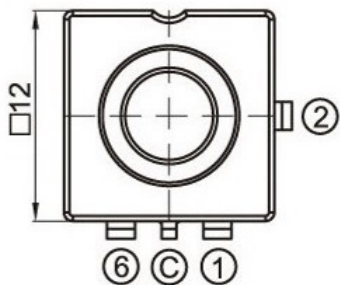
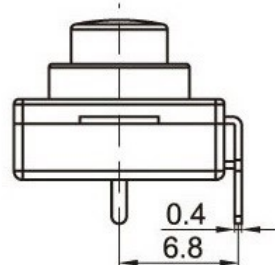
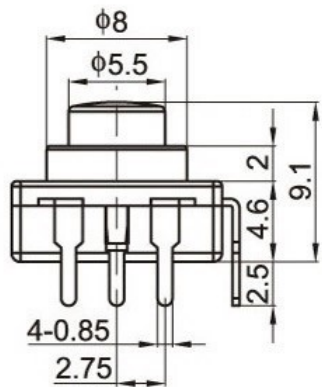
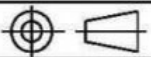

印制线路板  
P.C.B

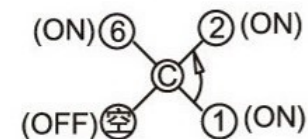

ON-ON-ON-OFF

SCHEMATIC (NON-SHORTING)

注：“\*”□表示关键尺寸(3个)。

NO.	PARTS	MATERIALS	Q'TY		TOLERANCE UNLESS SPECIFIED				
8									
7									
6					WITHIN 1.5mm : ±0.1mm	A	2012-8-13	初版	
5	SPRING	SUS	1	NATURAL	OVER 1.5mm : ±0.2mm	ISSUE	DATE	DESCRIPTIONS OF REVISION	APPD.
4	CAM STICK	SUS	1	NATURAL	TITLE : VERTICAL PUSH SWITCH		UNIT : mm	DRWG NO.:	
3	CASE	PA66/BRASS STRIP	1	GREY/Ag PLATED	MODEL:		SCALE: 5:1	DWN.	2012-8-13
2	COVER	PA66	1	BLACK	东莞市高迪电子有限公司			CHK'D	
1	KNOB	PA66/PBS C5210R-EH	1	WHITE/Ag CLAD				APPD.	
NO.	PARTS	MATERIALS	Q'TY						



